

Begin with a square of between 15 and 20cm, with the white side faced up. Fold diagonally in half.

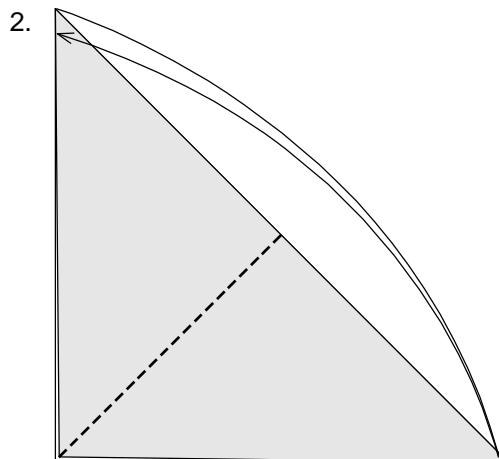

Fold diagonally in half again, crease firmly, and unfold.

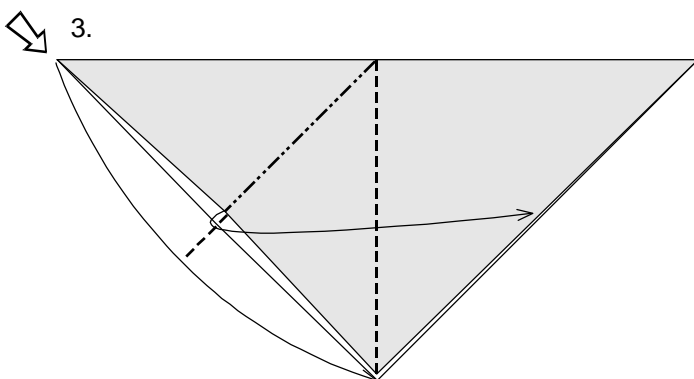

Separate the two vertical edges on the right and squash fold.

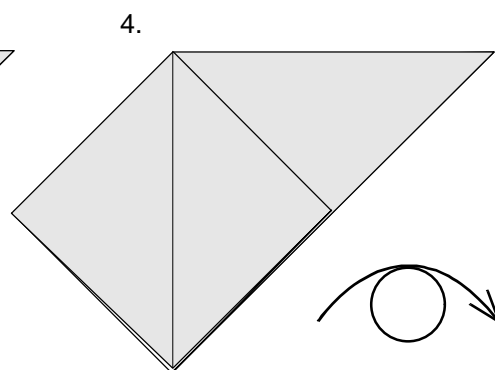

Turn the model over ...

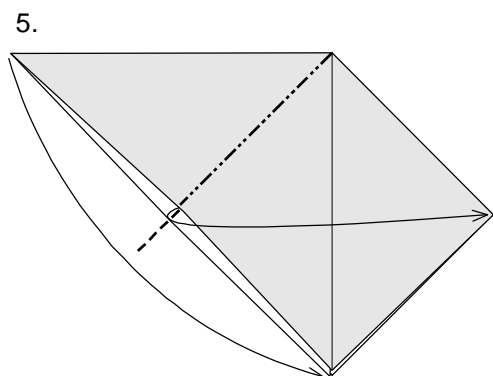

... and repeat Steps 3 and 4 on this side.

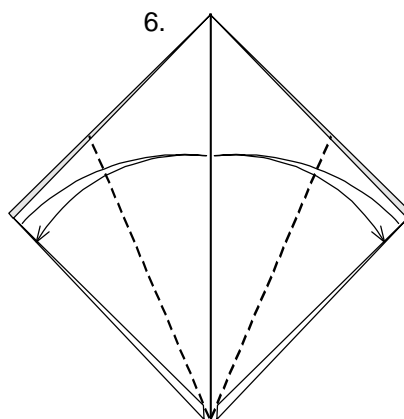

Fold the lower diagonal edges to the centre, crease firmly, and unfold.

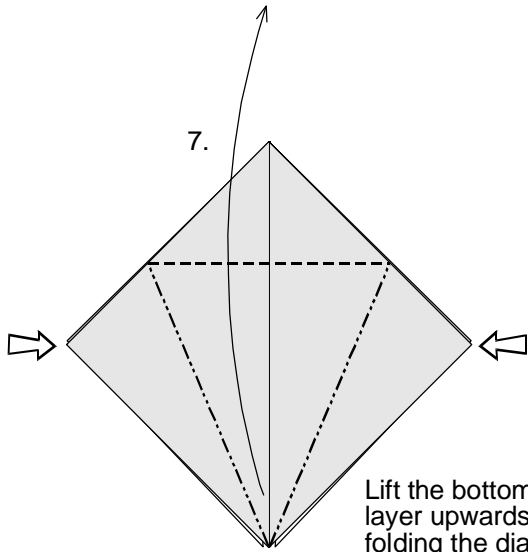

7. Lift the bottom corner of the first layer upwards while reverse folding the diagonal sides along the crease lines made in Step 6.

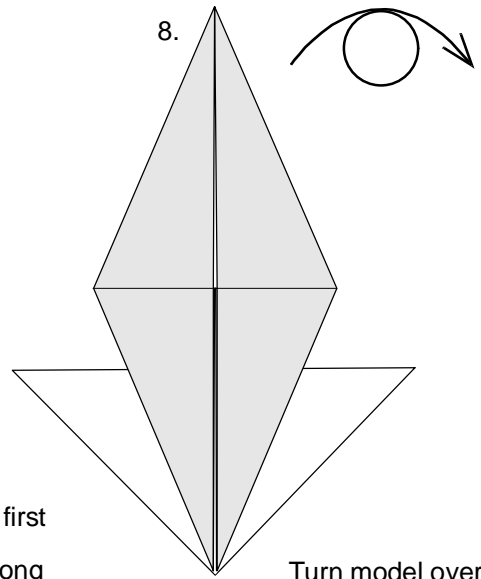

8. Turn model over

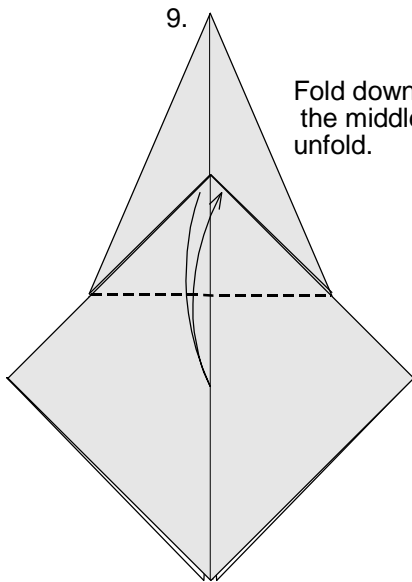

9. Fold down the triangular piece in the middle, crease firmly, and unfold.

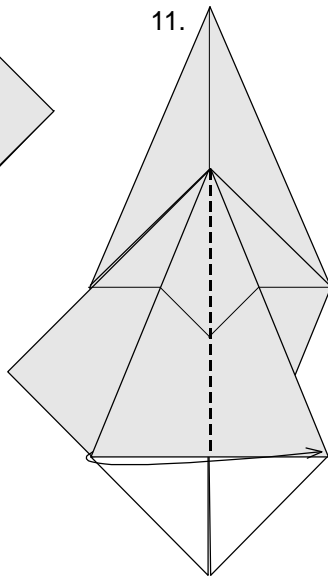

11.

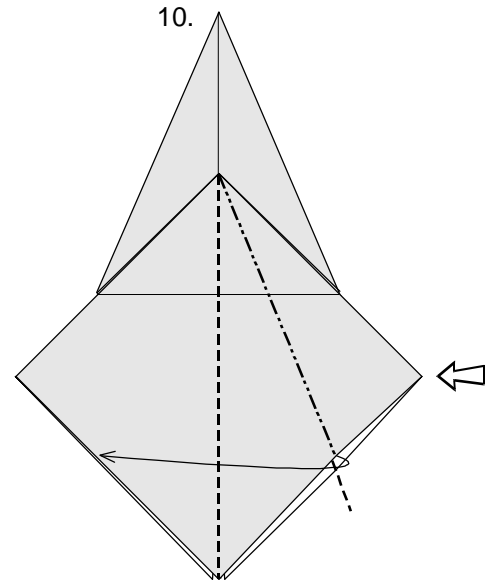

10. Separate the two diagonal edges on the right and squash fold ...

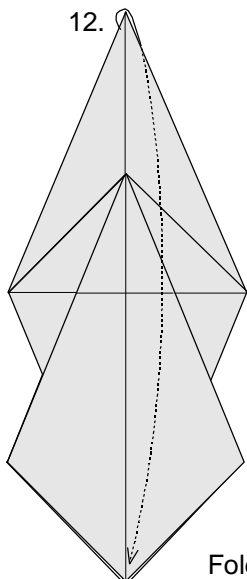

12.

12. Fold down the flap at the back.

... then swivel the first flap on the left to the right, and repeat Step 10 on the second flap on the left.

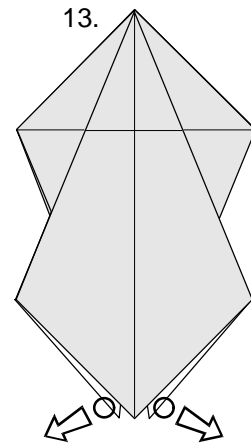

13.

13. Grasp the paper at the circled positions and pull apart ...

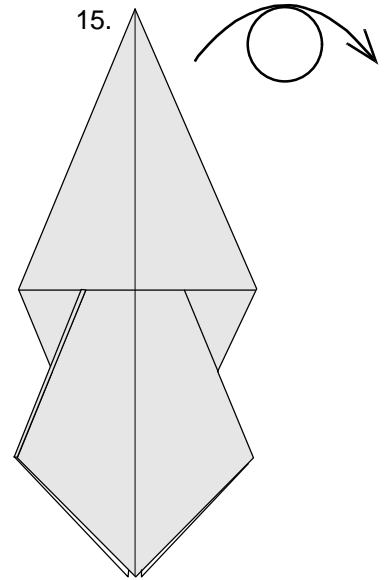
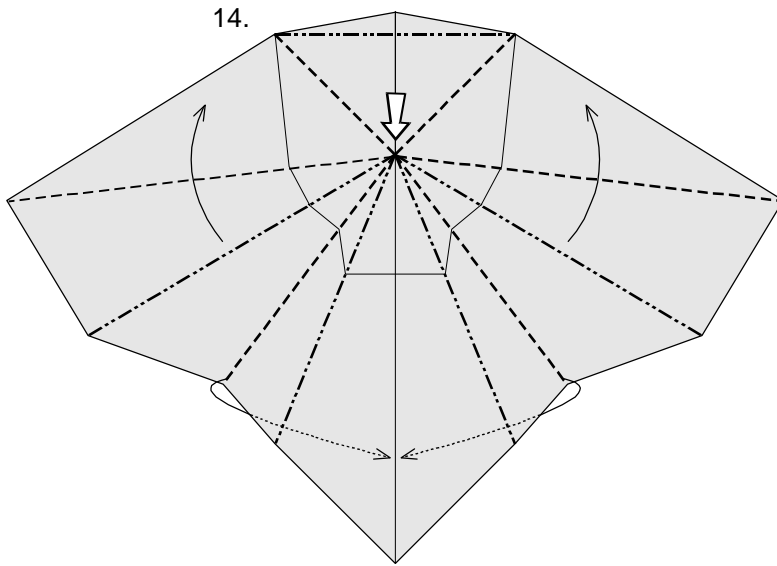

... then push in the centre where the diagonal creases intersect and collapse the paper again along the existing mountain and valley fold lines.

Your model should now look like this. Turn model over.

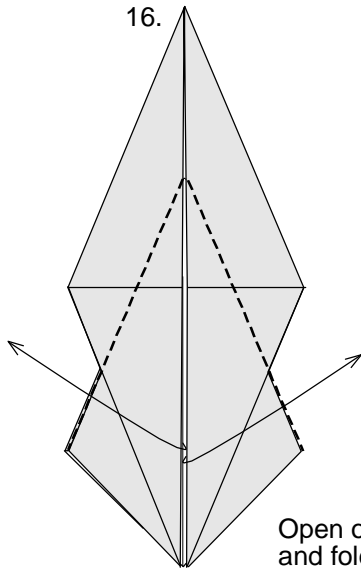

Open out from the centre and fold the first two layers to each side.

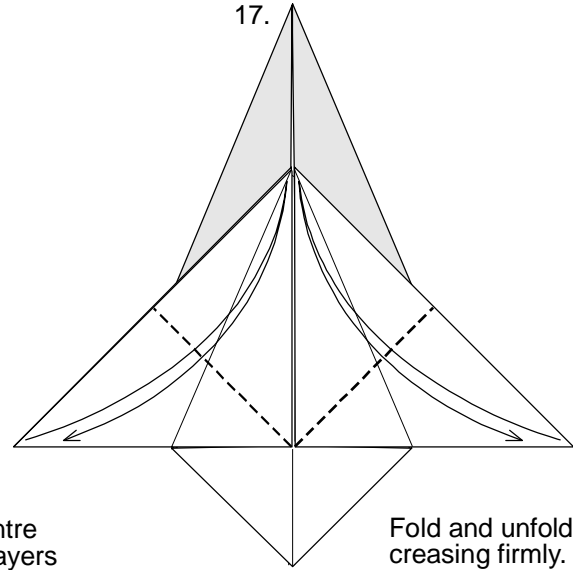

Fold and unfold, creasing firmly.

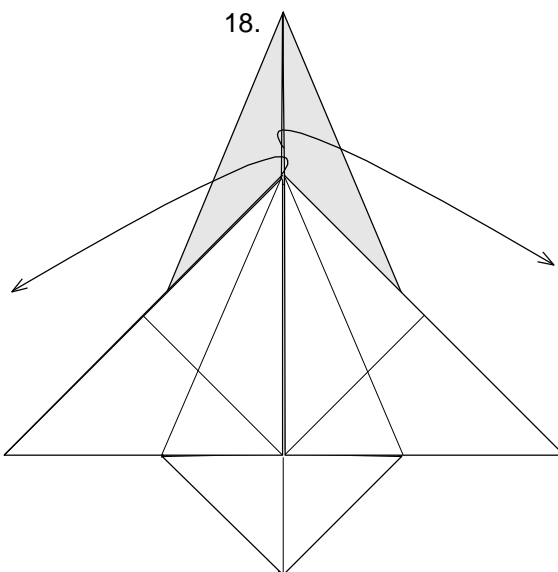

Unfold model completely.

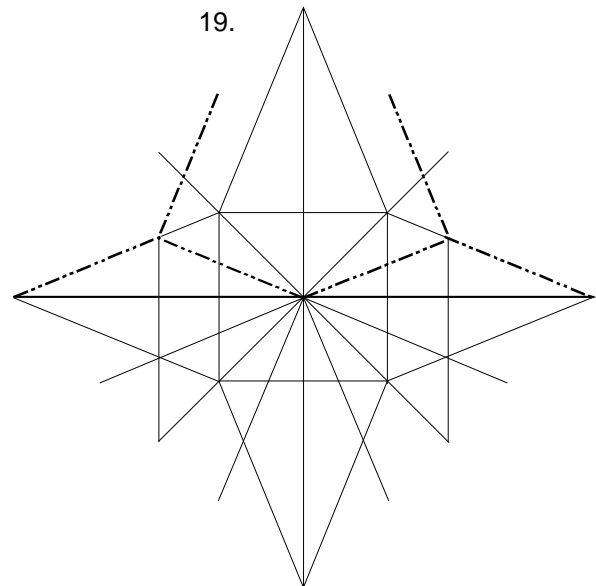

Recase the indicated valley fold lines as mountain folds. This will make Step 20 easier.

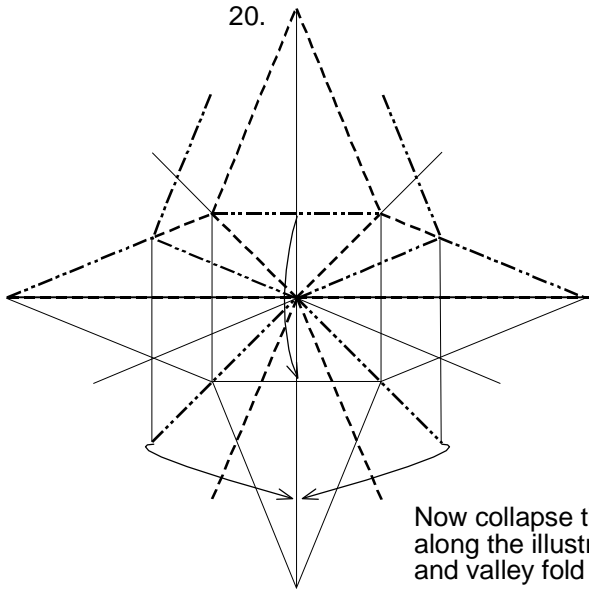

Now collapse the paper again along the illustrated mountain and valley fold lines ...

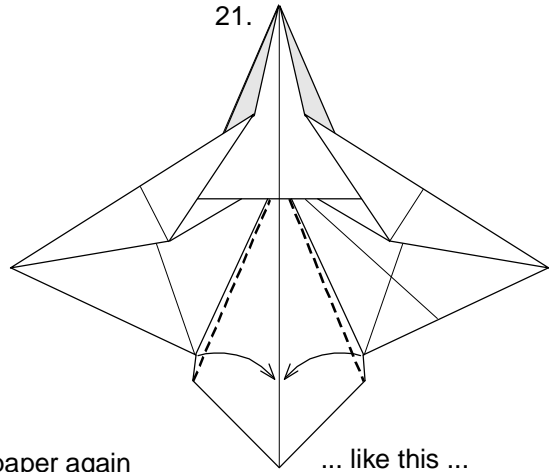

... like this ...

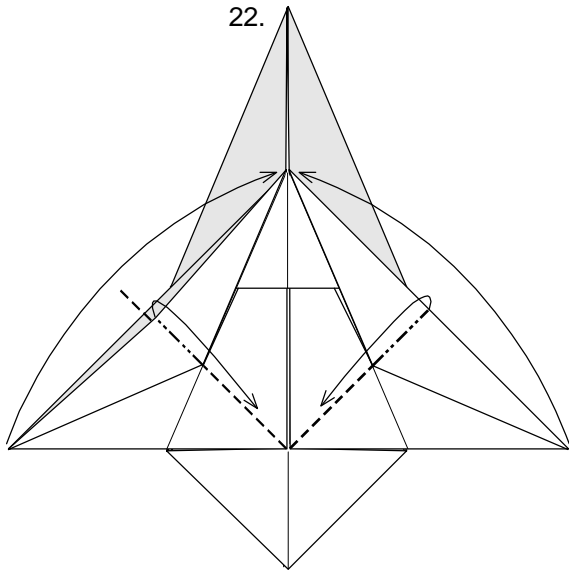

Separate and draw the diagonal edge of the first layer of the flaps on each side towards the centre, then fold the corners at the sides to meet the top corner of each triangle.

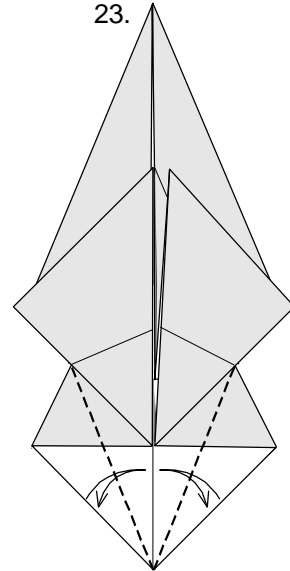

Fold as shown, crease firmly, and unfold.

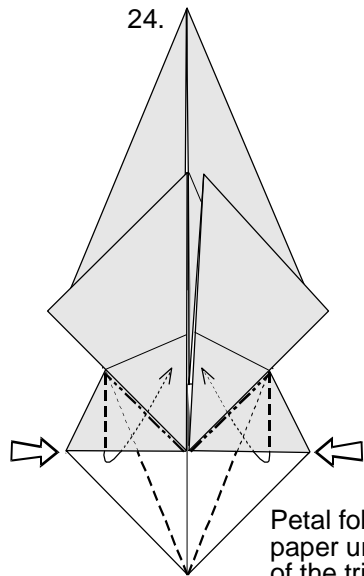

Petal fold, tucking the excess paper under the lowest corner of the triangular pieces above.

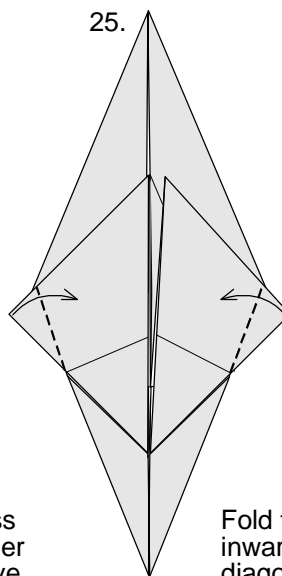

Fold the excess corners inwards, in line with the diagonal edge at the bottom.

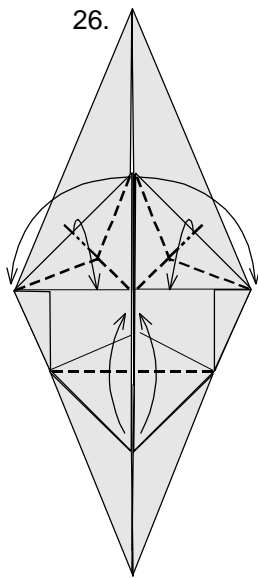

26. Fold up the lower triangular flaps and rabbit's ear fold the upper pieces ...

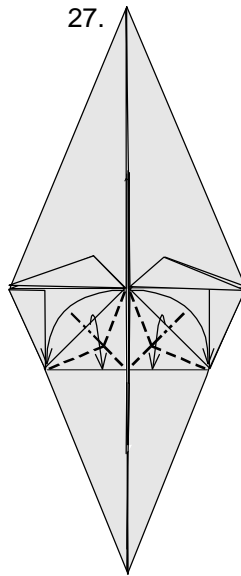

27. ... then rabbit's ear fold the lower pieces ...

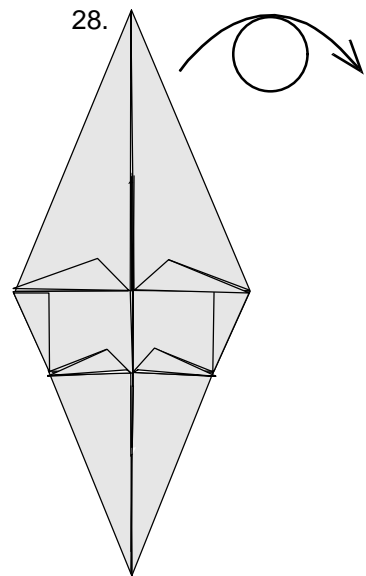

28. ... like this. Now turn the model over.

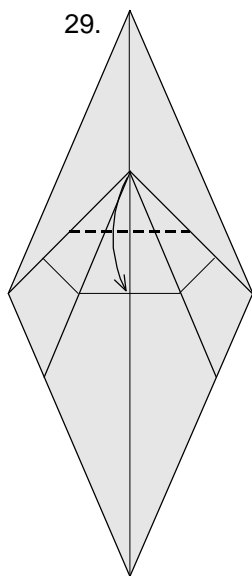

29. Fold the tip of the triangle to the intersecting crease lines as shown ..

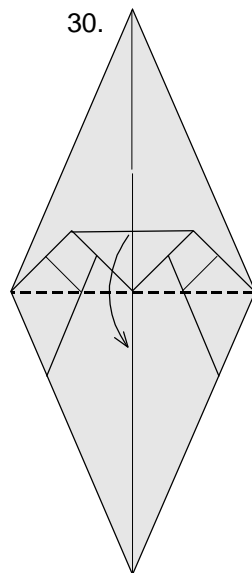

30. ... then fold this piece all the way down from the horizontal mid-point of the model.

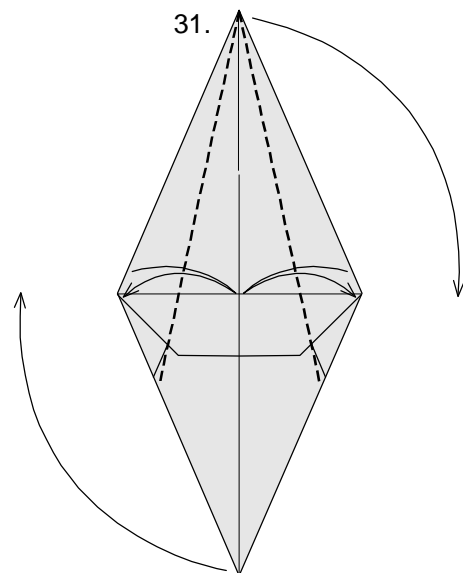

31. Fold the upper diagonal edges to the centre, crease firmly, and unfold, then rotate the paper clock wise through 90 degrees.

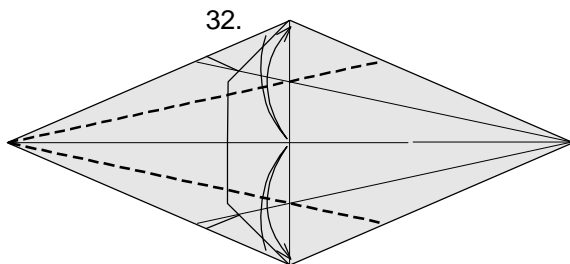

32. Fold and unfold on the left, as in Step 31.

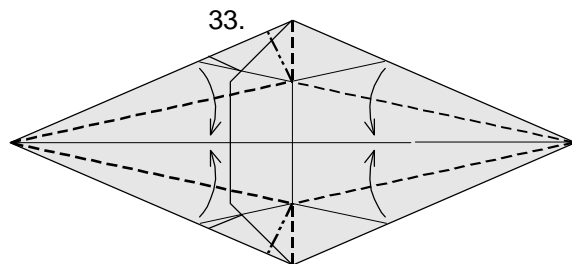

33. Now bring the four diagonal edges to the centre as illustrated, Note the crimps in the centre.

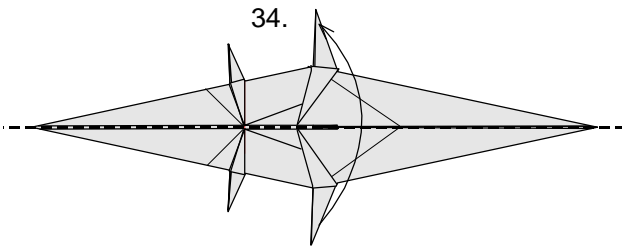

34.  
Fold the model horizontally in half

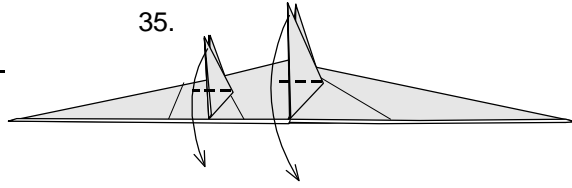

35.  
The four vertical pieces will form the legs. Fold down the two on this side and repeat at the back.

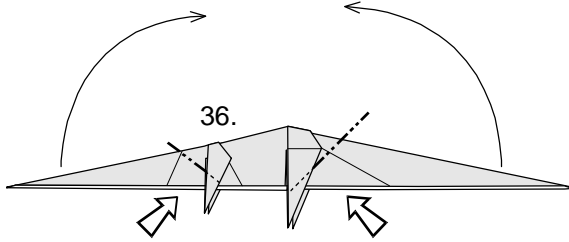

36.  
Reverse fold on the right and left.

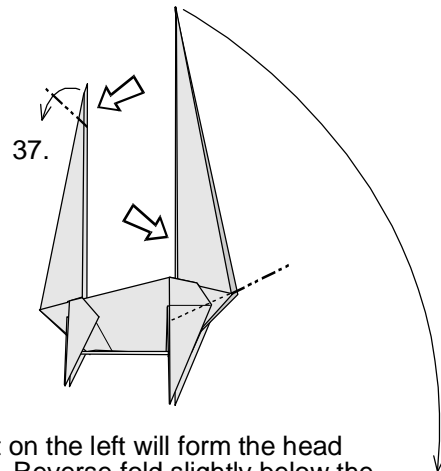

37.  
The point on the left will form the head and neck. Reverse fold slightly below the tip, then reverse fold again at the base of the tail piece on the right.

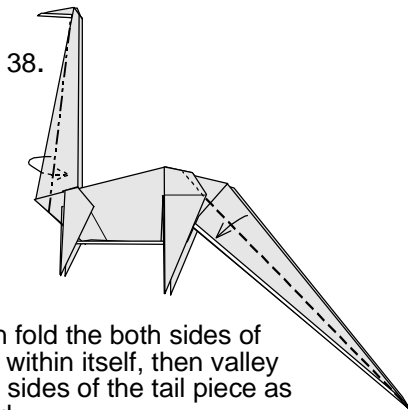

38.  
Mountain fold the both sides of the neck within itself, then valley fold both sides of the tail piece as illustrated.

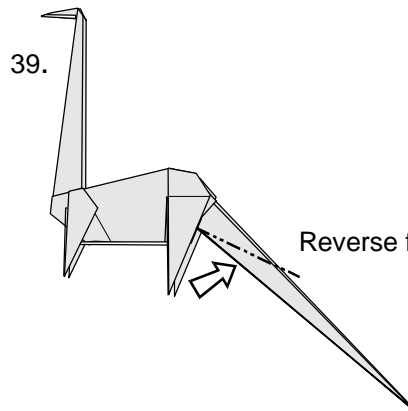

39.  
Reverse fold the tail again.

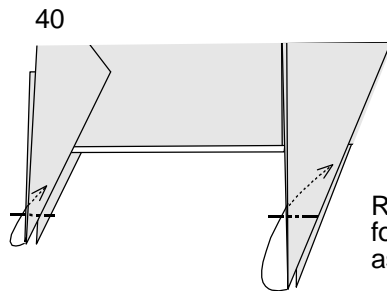

40.  
Reverse fold the tips of all four legs within themselves as illustrated.

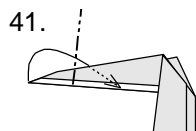

41.  
Now for the head. Inside reverse fold ...

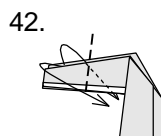

42.  
... then outside reverse fold ..

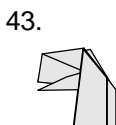

43.  
... like this, and the diplodocus is done.

