

# Santa by Steven Casey

Begin with a square white side up.

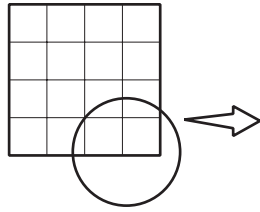

1. Precrease into 4 x 4 using Valley folds. Scale change.

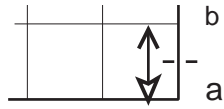

2. Fold a to b. Pinch. Unfold.

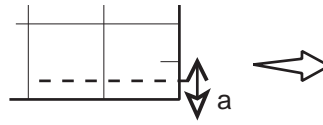

3. Fold a to pinch mark. Unfold. Scale change.

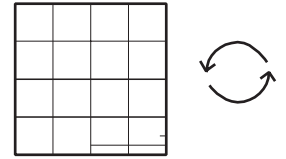

4. Rotate 90 degrees to the left.

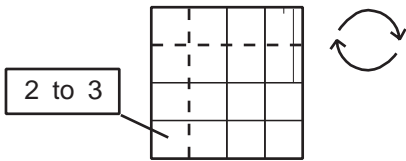

5. Repeat steps on the left side. Rotate to position in step 4.

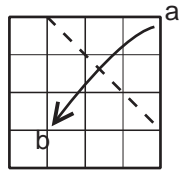

6. Fold a to b. Creases made in steps 2 to 5 not shown until step 30.

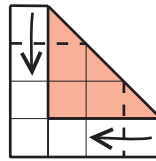

7. Valley top and right edges.

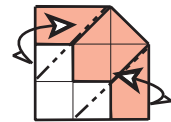

8. Mountain fold behind. Unfold.

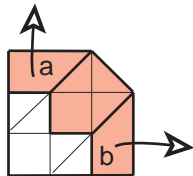

9. Open out flaps a and b.

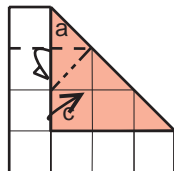

10. Lift c slightly, and allow a to slip under.

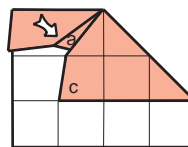

11. This shows the fold in progress.

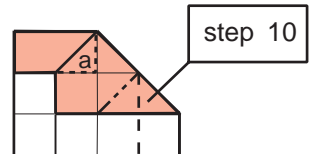

12. Repeat step 10 where shown.

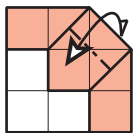

13. Mountain fold. Unfold.

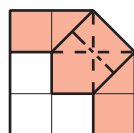

14. Collapse into a waterbomb base.

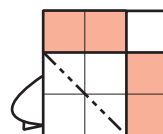

15 Mountain fold.

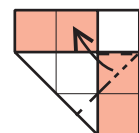

16 Swival fold.

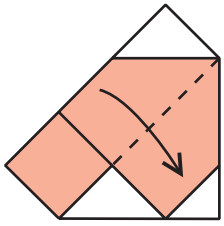

17. Valley.

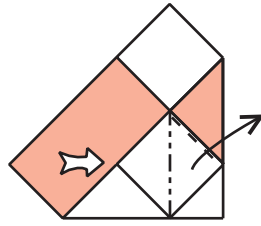

18. Sink then valley.

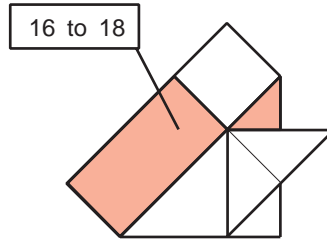

19. Repeat steps other side.

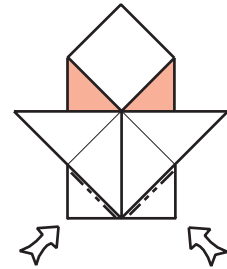

20. Sink bottom corners

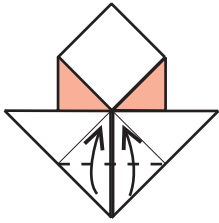

21. Valley both points up.

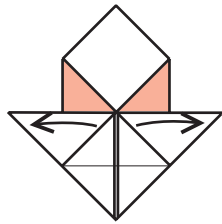

22. Pull points outward.

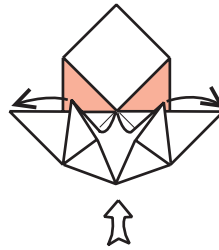

23. Shows the fold in progress.

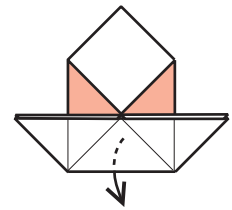

24. Unfold flap from behind.

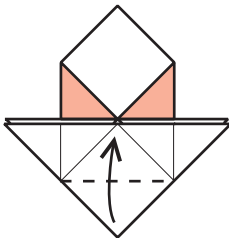

25. Valley top layer.

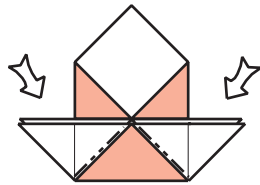

26. Reverse fold two top points.

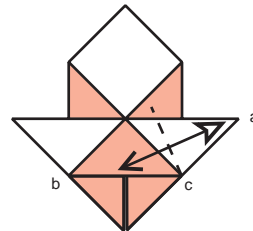

27. Fold double raw edge a - c along closed edge b - c. Unfold.

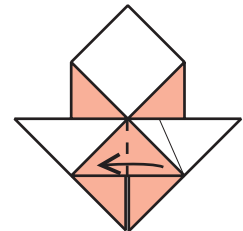

28. Valley top flap to the left.

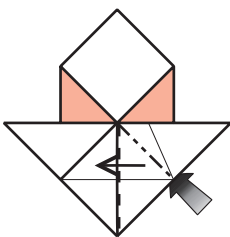

29. Squash fold.

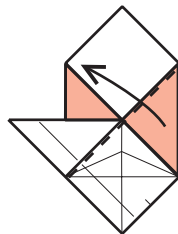

30. Valley top flap up. Creases made in step 2 to 4 now shown.

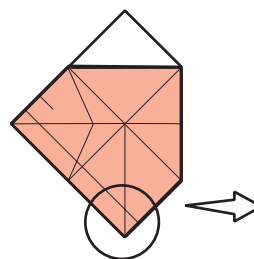

31. See detail. Scale change

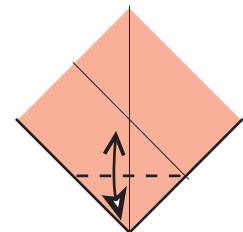

32. Fold corner up to intersection of diagonal and centre crease. Unfold.

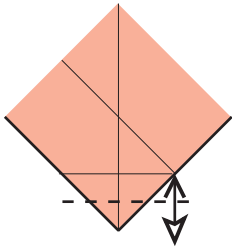

33. Valley corner up to Horizontal crease. Unfold.

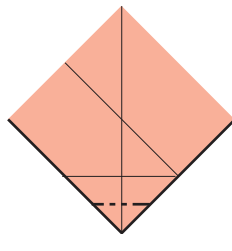

34. Sink.

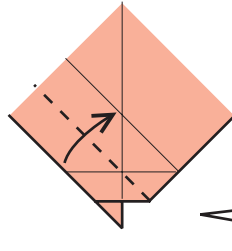

35. Valley entire edge to diagonal crease. Scale change.

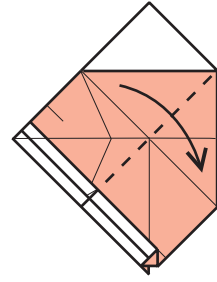

36. Valley diagonal.

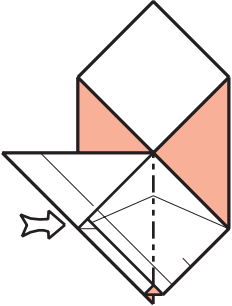

37. Sink.

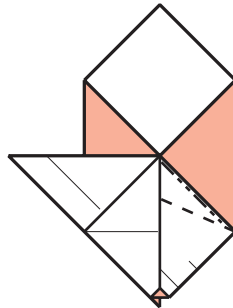

38. Double reverse fold.

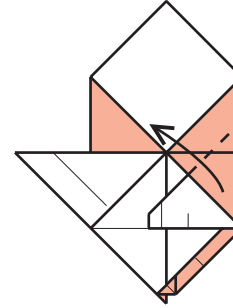

39. Valley fold.

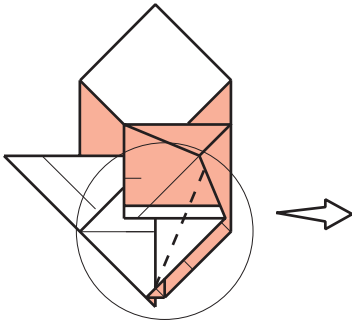

40. See detail next step.

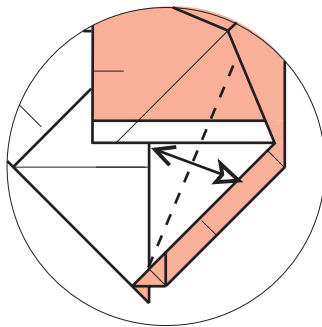

41. Valley fold. Unfold.

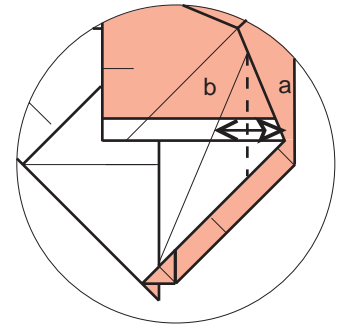

42. Fold edge "a" across to diagonal crease "b". Unfold.

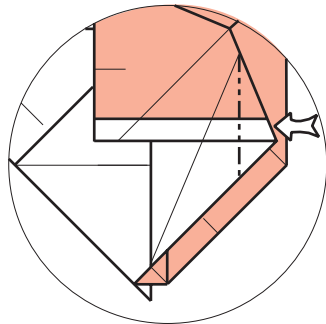

43. Sink.

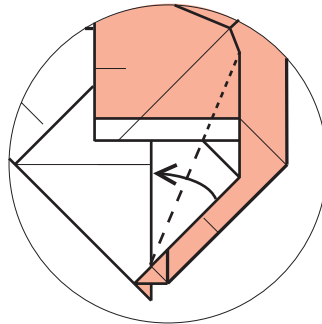

44. Combination valley/sink.

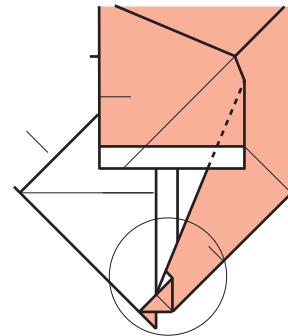

45. See detail next step.

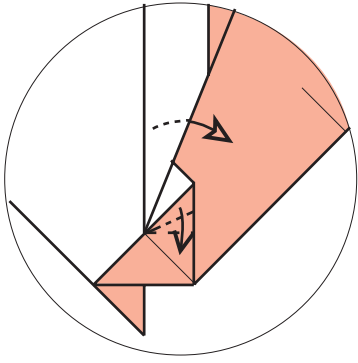

46. Pull out trapped layer.  
Swival fold.

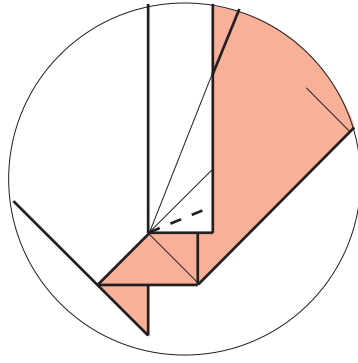

47. Valley fold.

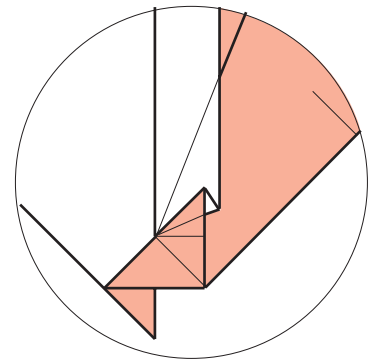

48. The result.

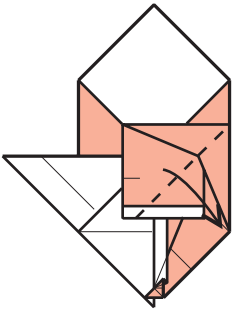

49. Valley fold.

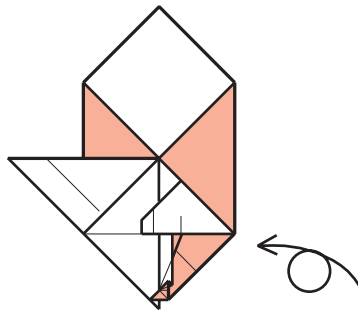

50. Turn over right  
to left.

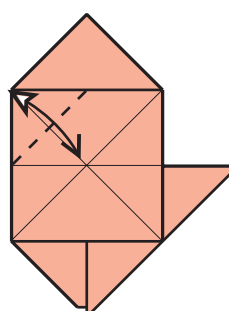

51. Valley. Unfold.

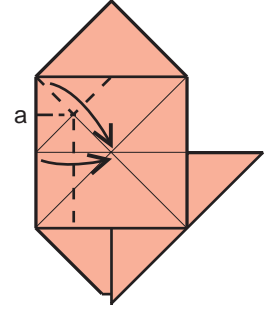

52. Collapse.

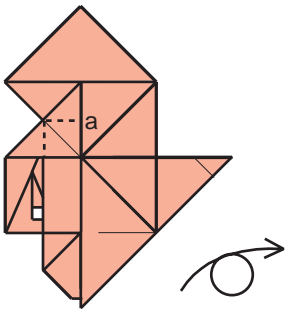

53. This is the result.  
Turn over.

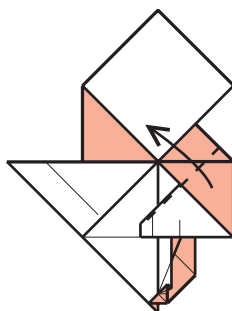

54. Valley flap up.

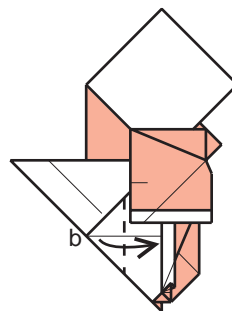

55. Valley corner "b".

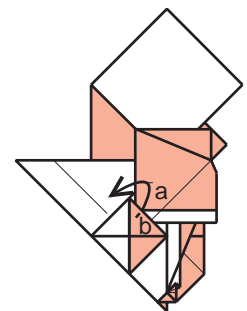

56. Place flap "a" over  
"b".

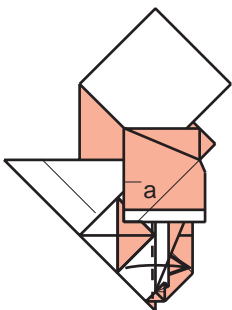

57. Valley fold , partly  
under flap "a".

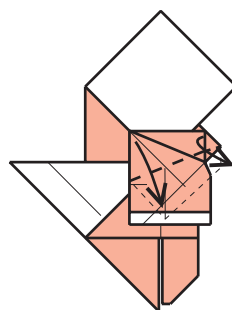

58. Valley fold flap down  
and pull out corner  
pocket.

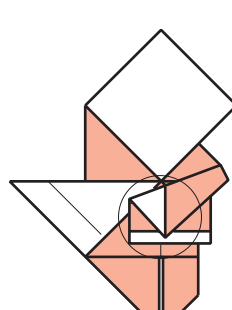

59. See detail.

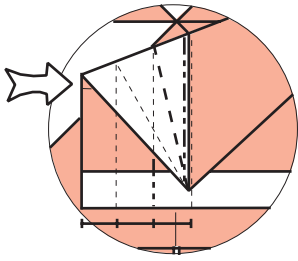

60. Double reverse fold.  
Look ahead to next  
step.

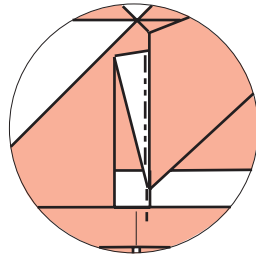

61. Reverse fold.

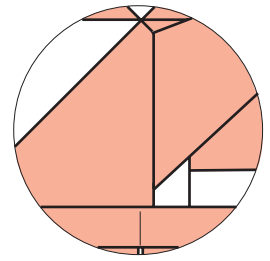

62. Next step shows  
a full view.

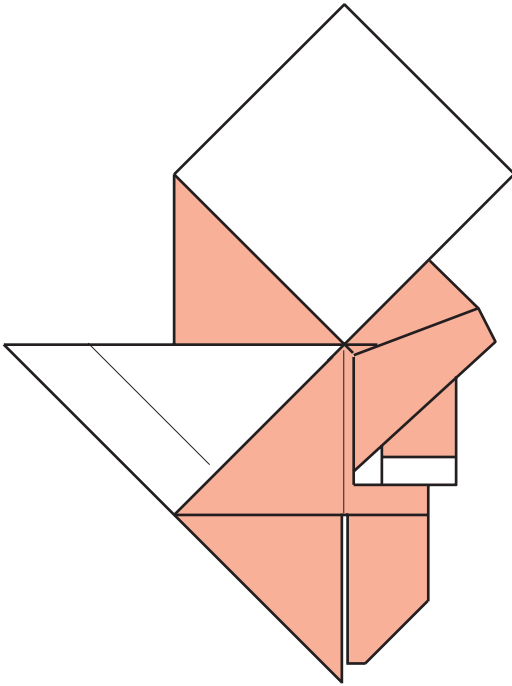

63. Repeat steps 27 to 62  
other side.

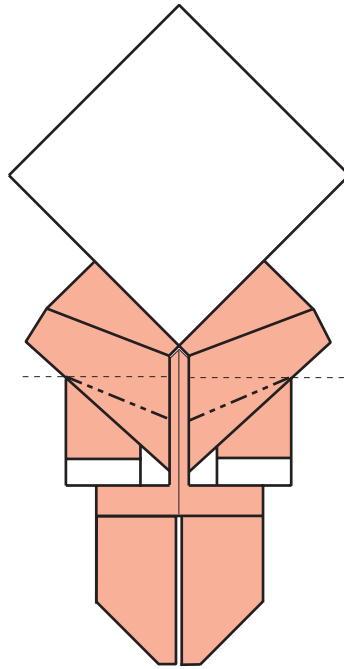

64. Reverse fold to  
form hands.

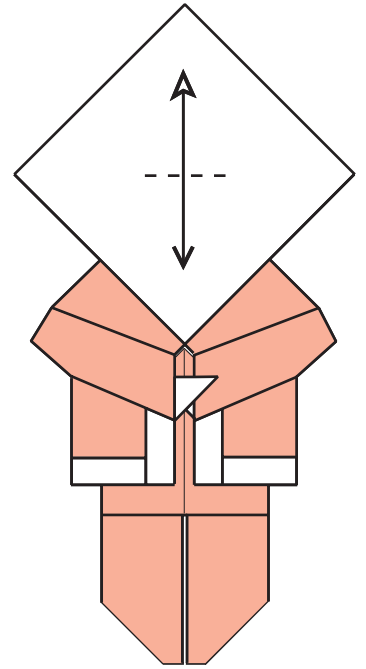

65. Valley fold then unfold.  
Next steps show only  
the upper section.

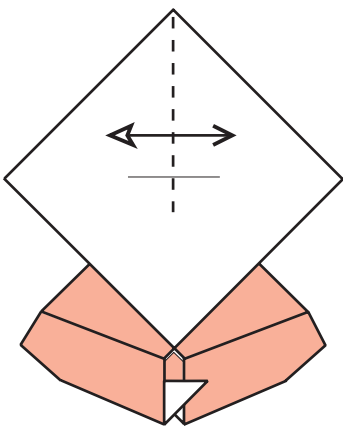

66. Valley fold in half.  
Crease only where  
shown. Unfold.

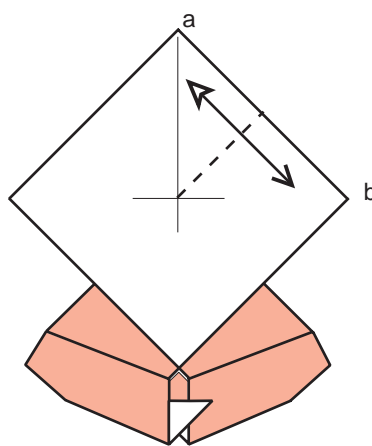

67. Fold "a" to "b" crease  
only where shown.  
Unfold.

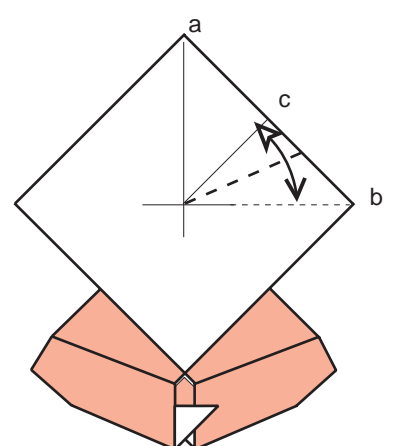

68. Valley fold "c"  
down in line  
with "b". Unfold.

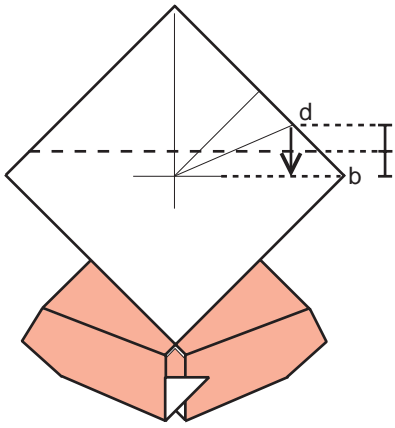

69. Valley fold "d" down in line with "b".

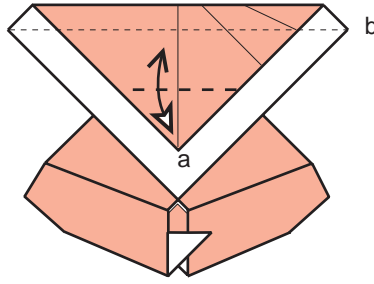

70. Valley corner "a" so that it lines up with corner "b"

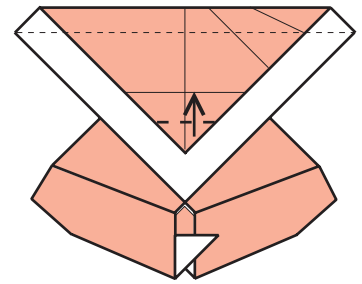

71. Fold the corner up to the horizontal crease.

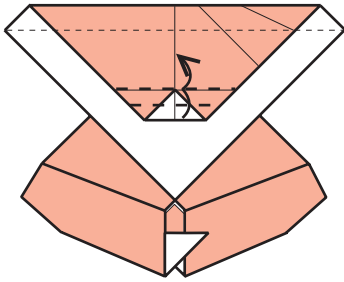

72. Fold over and over.

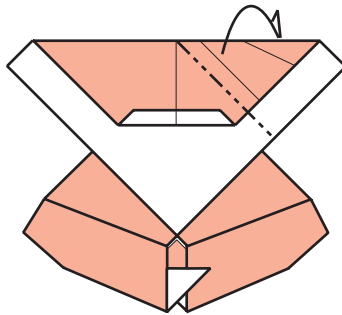

73. Mountain fold.

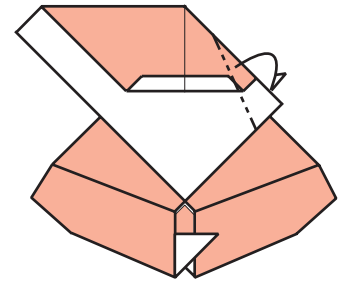

74. Mountain fold.

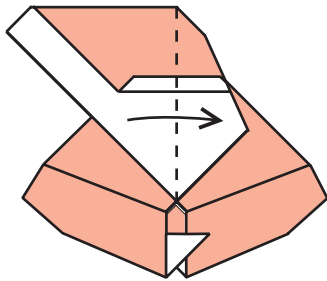

75. Valley in half.

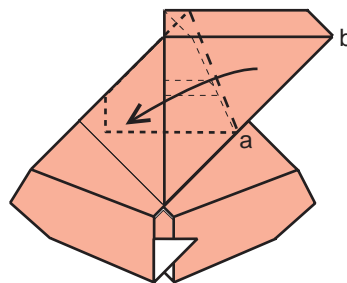

76. Starting at point "a" valley the flap down so that edge a - b lies horizontal.

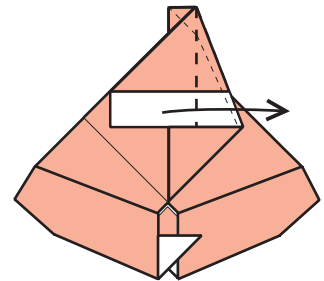

77. Valley over to the right.

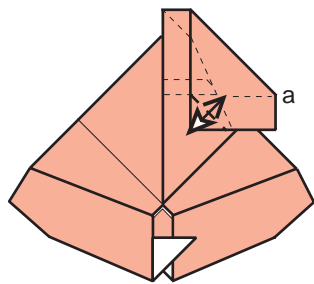

78. Fold corner up in line with point "a". Unfold.

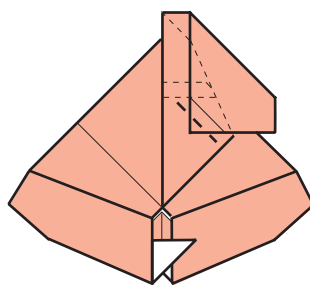

79. Fold corner up to Diagonal crease.

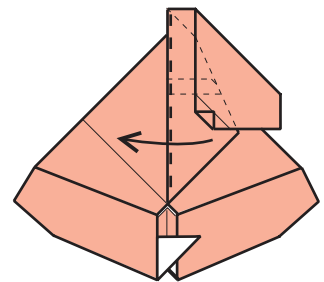

80. Valley top flap over to the left.

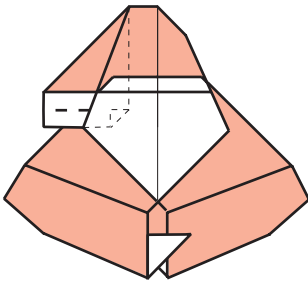

81. Valley edge up to the coloured edge.

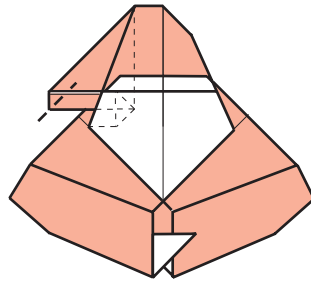

82. Note there will be some paper creep, resulting in a small strip of white edge. Valley the corner down to form a tassel.

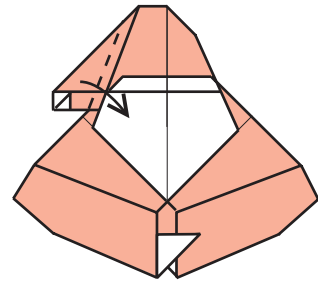

83. Valley onto left side of face.

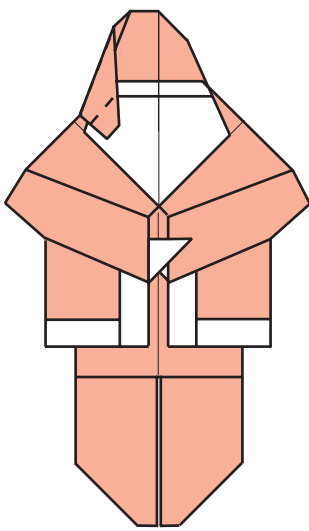

84. Valley lower part of hat to reveal the tassel.

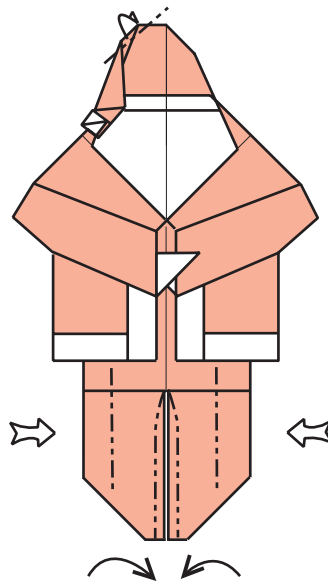

85. Mountain fold to finish off the hat. Press legs into a half square tube shape using mountain folds.

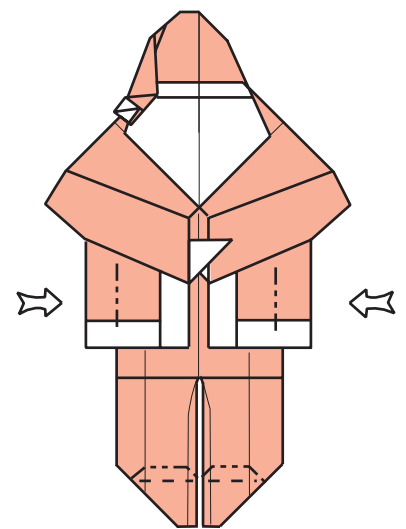

86. Double reverse fold "tubular" legs to form feet. With a little adjustment the model will stand.

